













METAL KLİPSLER

Bağlantı klipslerimiz müşterilerimizin ihtiyaçları doğrultusunda uzman Ar-Ge kadromuz tarafından tasarlanıp, geniş makine parkımızda üretilerek otomotiv, beyaz eşya, elektrik, elektronik, aydınlatma, iklimlendirme ve benzeri birçok sektörde tasarlanış amacına yönelik tam performans gösteren bağlantı elemanlarıdır.



| | | | | | |
|--|--|--|---|--|--|
|  21-01-001 |  21-01-002 |  21-01-005 |  21-01-006 |  21-01-011 |  21-01-013 |
|  21-01-015 |  21-01-034 |  21-02-002 |  21-02-005 |  21-02-007 |  21-02-009 |
|  21-02-013 |  21-02-014 |  21-02-020 |  21-02-024 |  21-02-027 |  21-02-032 |
|  21-03-001 |  21-03-003 |  21-03-019 |  21-03-019 |  21-03-019 |  21-03-022 |
|  21-03-028 |  21-03-065 |  21-03-072 |  21-03-083 |  22-03-004 |  22-03-016 |

METAL KLİPSLER



Çok çeşitli tasarımlara sahip olan klipsler, metrik civata veya vidalara uyumlu olarak üretilmekle birlikte aynı zamandasıkıştırma ve sabitleme gerektiren birçok farklı uygulama için kullanılabilirler. Klipslerimizi tasarımı firmamıza ait olan otomatik metal form verme makinelerimiz sayesinde düşük kalıp maliyetleri ile seri bir şekilde üreterek müşterilerimize yüksek kalite standardı ile ekonomik çözümler sunmaktayız. Klipslerimiz standart ölçülerin yanı sıra müşterilerimizin tasarımlarına uygun olarak da üretilmektedir.

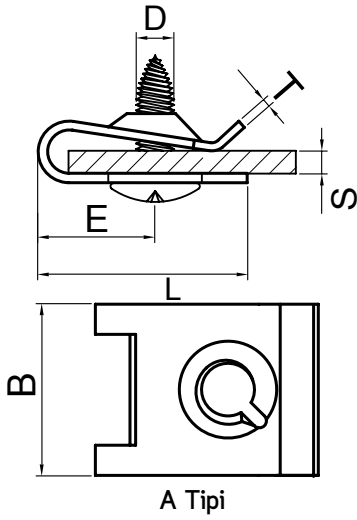

A Tipi

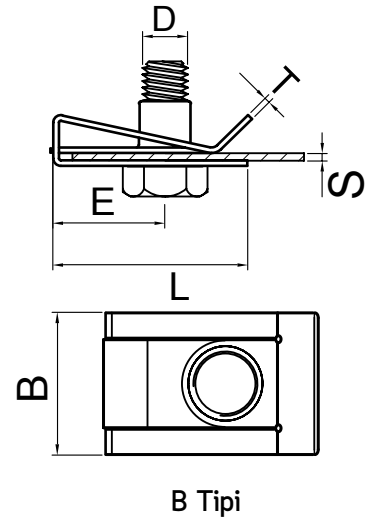

B Tipi

| Tanımı | Kodu | Tipi | D Vida | E (mm) | L (mm) | B (mm) | T (mm) | S (mm) | Malzeme | Resim |
|----------------|-----------|------|--------|--------|--------|--------|--------|-----------|---------|-------|
| 3,5 Vida Klips | 21-01-001 | A | Ø3,5 | 11 | 17,6 | 12 | 0,6 | 0,5 ~ 2 | Ck 67 | |
| 3,9 Vida Klips | 21-01-002 | A | Ø3,9 | 11 | 17,6 | 12 | 0,6 | 0,5 ~ 2 | Ck 67 | |
| 4,2 Vida Klips | 21-01-011 | A | Ø4,2 | 11,6 | 20,8 | 12 | 0,6 | 0,5 ~ 2 | Ck 67 | |
| 4,2 Vida Klips | 21-01-044 | A | Ø4,2 | 8,7 | 15,2 | 12 | 0,7 | 0,5 ~ 2 | Ck 67 | |
| 4,8 Vida Klips | 21-01-006 | A | Ø4,8 | 8,7 | 15,2 | 12 | 0,7 | 2 ~ 3,5 | Ck 67 | |
| 4,8 Vida Klips | 21-01-009 | A | Ø4,8 | 11,5 | 20,6 | 14 | 0,6 | 0,5 ~ 2 | Ck 67 | |
| M4 Yay Klips | 21-02-009 | B | M4 | 5,8 | 15,3 | 10 | 0,6 | 0,5 ~ 1,5 | Ck 50 | |
| M5 Yay Klips | 21-02-002 | B | M5 | 11,5 | 20,5 | 14,3 | 0,6 | 0,5 ~ 3 | Ck 50 | |
| M6 Yay Klips | 21-02-005 | B | M6 | 12,5 | 23,2 | 16 | 0,8 | 0,5 ~ 2 | Ck 50 | |
| M8 Yay Klips | 21-02-014 | B | M8 | 14,5 | 24,3 | 16,6 | 1 | 2 ~ 3 | Ck 50 | |

Not: İsteğe bağlı olarak farklı kaplama seçenekleri mevcuttur.